

# **SERVICE MANUAL**

for

**PureWaterCooler™**

by Vertex

**Model PWC-600/2000**

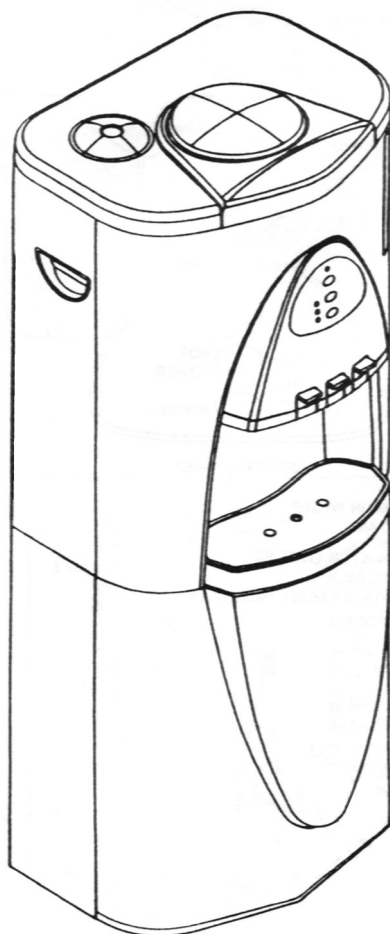

P/N man-7006

## Table of Contents

1. Introduction
2. Cooler Set-up
3. Front Cover Installation
4. Remove Top and Back Covers
5. Remove Circuit board and Faucet Cover
6. Remove/Replace Float Switch
7. Remove/Replace Hot Tank
8. Remove/Replace Faucet
9. Draining Cooler Tanks
10. Remove/Replace Hot Tank Sensor
11. Remove/Replace Cold Temperature Switch and Sensor
12. Sanitization Procedure
13. Trouble Shooting
14. Specifications
15. Model PWC-3000 Cooler
16. Cooler Exploded View
17. Parts List
18. Schematics

## PWC-2000 Cooler

### 1. Introduction

The PWC-2000 line of point of use coolers are designed to give years of reliable service. The cooler has 3 spigots that dispense filtered water at 3 different temperature levels – room temperature, hot, and cold temperature water. The main (room-temp) tank holds 2.2 gallons of water and is constructed of bacteria resistant plastic. The main tank can be accessed for servicing the float mechanism and for cleaning by removing the cooler main top cover and then the room temperature tank cover (see section 4).

The cold tank is made of stainless steel and holds ½ gallon. The tank is not serviceable in the field as it has the compressor evaporator coils wound tightly around it. If the cold tank needs service, please call the factory or consult with a local refrigeration specialist.

The hot tank is made of stainless steel and holds ½ gallon. It is important not to turn on the hot tank when there is no water in it as this will damage the heating element. There are two types of hot tanks in the PWC-2000 PureWaterCooler. The heating band style utilizes a heating element that wraps around the outside of the hot tank. This hot tank style does not have insulation on the tank. This version was produced up until November 2002.

The “heating pipe” style of hot tank is recognized by the foam insulation on the circumference of the tank. The heating element is inside this sealed tank with the two electrical connections for the heating element protruding from the bottom of the tank. This version is available on all PWC-2000 coolers produced after November 2002.

The compressor is a sealed unit and is not serviceable in the field. The compressor can be replaced by a qualified refrigeration technician with proper tools and equipment. Please consult the factory if the compressor needs servicing.

The cooler makes clean water by filtration or the reverse osmosis process. Water enters the back of the cooler and then passes through the filtration system. A feed water ball valve is located near the filters and must be turned to the on position to allow the unit to make water. When the cooler is plugged in, the feed water solenoid valve is activated, allowing clean water to fill the tanks. When the tanks are full, the float valve in the main tank deactivates the feed water solenoid valve, and water production is stopped. **CAUTION:** The carbon filtration versions of the cooler (PWC-2000F) should not be used with water hardness over 7 grains because of lime scale build up on the heating element. If hardness is higher than 7 grains, softening of the water is recommended.

## 2. Cooler Set-Up (for new cooler installation)

### Remove Lower Front Panel/Access Filters

- 2.1 Tilt cooler back  
(NOTE: For model PWC-3000 grab lower panel at bottom mid-point and simply pull forward)



- 2.2 Depress on of the tabs under the base

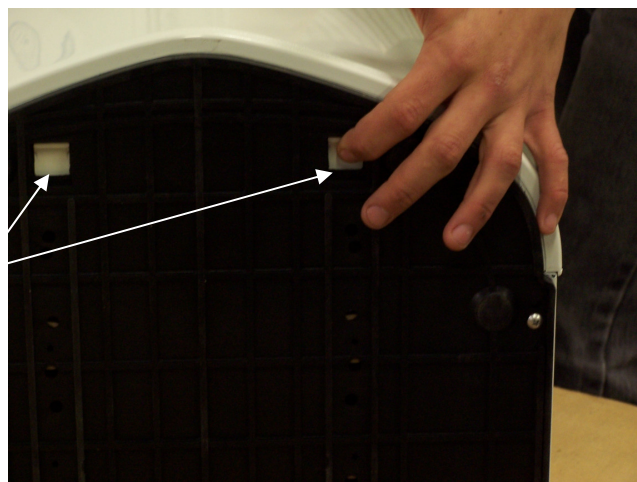

- 2.3 Pull panel forward and off



## 2. Cooler Set-Up cont.

### Feedwater/Drain Connections

-Feed Connection

2.3 Pull panel forward and off

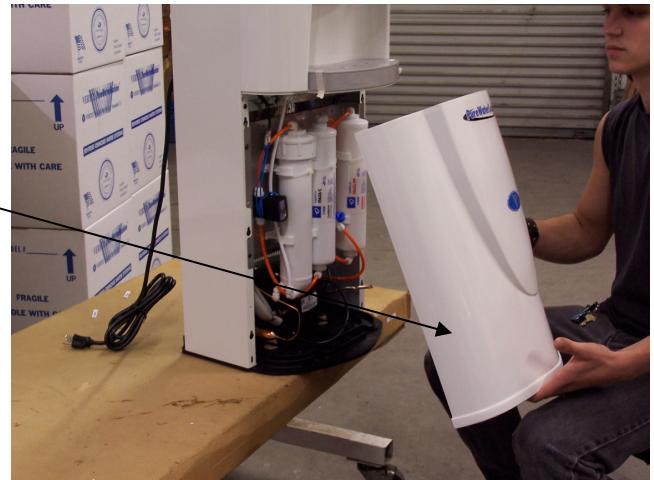

2.4 Turn plastic ball valve to on position (handle in line with tubing)



2.5 Remove feed water plug (orange) from back of cooler.

2.6 Connect supplied orange feed water tubing to feed connector on back of cooler.

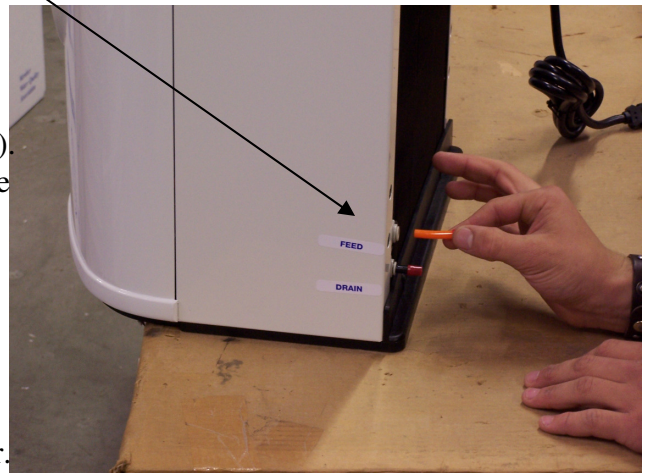

2.7 Connect orange line to cold water line (figure 2.7).  
A self-piercing saddle valve is provided to be the cold water line connection. The self-piercing valve is designed to be used on copper pipe only.

2.8 Caution: Filter only units (PWC-2000F) can only be used on water that is soft (less than 10 grains) or has a water softener installed to treat the water.

## 2. Cooler Set-Up cont.

### -Drain Connection

- 2.9 Drain Connection (for units equipped with RO)
- 2.10 Remove drain plug (black) from back of cooler
- 2.11 Connect supplied black water tubing to drain connector on back of cooler
- 2.12 Attach supplied drain saddle to a standard 1 1/2" drain pipe see fig. 1 below
- 2.13 Turn on feed water at cold water line
- 2.14 Turn on feed water ball valve at filters
- 2.15 Plug in cooler (Do not turn on hot tank at this time)
- 2.16 Feed water solenoid valve will open
- 2.17 Water will start to flow through the filters into the main tank

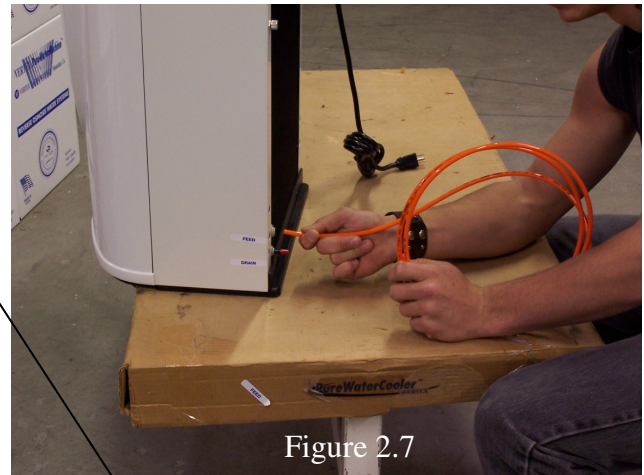
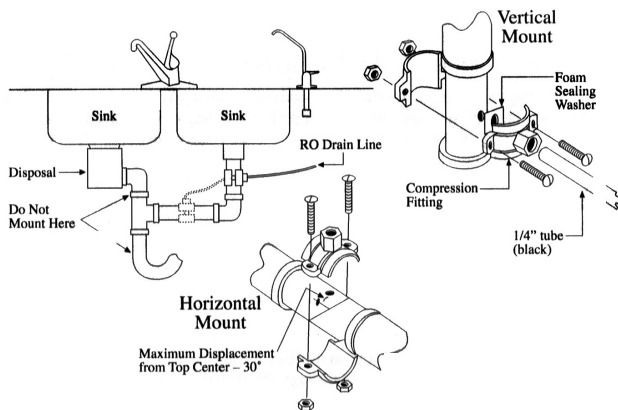
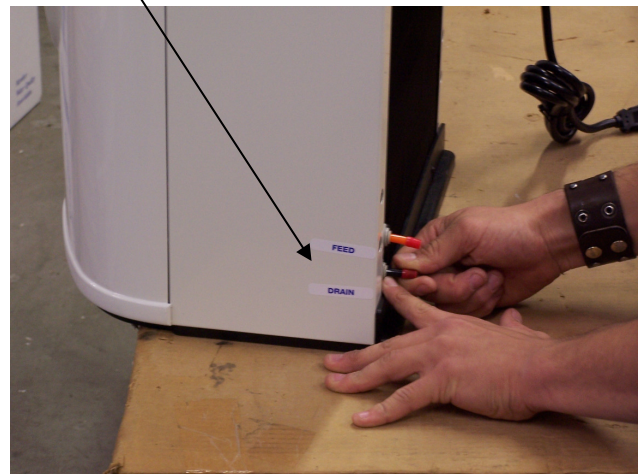

Figure 2.7



Drain saddle connection method

Drain connection required only for cooler with reverse osmosis filtration

**Figure 1**

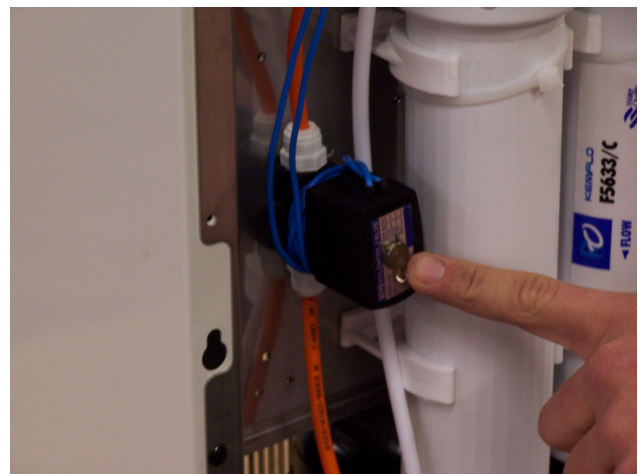

Feed water Solenoid Valve activates when cooler is plugged in.

## 3. Front Cover Installation

3.1 To replace front panel – install bottom section on cooler base



3.2 Install center of upper section (near drip tray)



3.3 With palm of hand, hit left and right side of upper panel to finish installation. This will snap the tabs into place.



## 4. Remove top cover and back cover

### 4.1 Remove the round top cover



### 4.2 Firmly pull up on the main top cover to remove it (NOTE: on PWC-3000 model remove 2 holddown screws rear of main top cover first.)



### 4.2 Lift off Main Tank inner cover

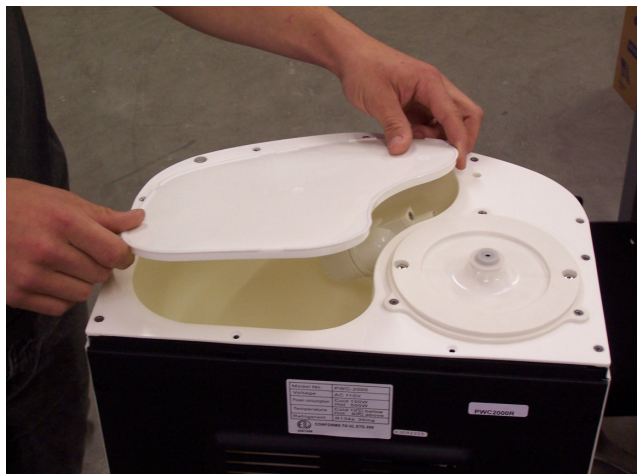



## 4. Remove top cover and back cover

continued

4.3 The Main Tank and float are now accessible



4.5 Back Cover



4.6 Remove 6 screw from back cover and lift off



## 5. Removing/Replacing Faucet Cover and Circuit Board

5.0 Push down firmly on the top portion of the faucet cover.



5.1 The top part of the cover will disengage from the cooler.



5.2 Carefully pivot the top of the cover forward and clear the 3 faucets.



## 5. Removing/Replacing Faucet Cover and Circuit Board

Cont.

- 5.3 The circuit board has 3 wire assemblies connected to it. Remove the 3 different connectors from the circuit board

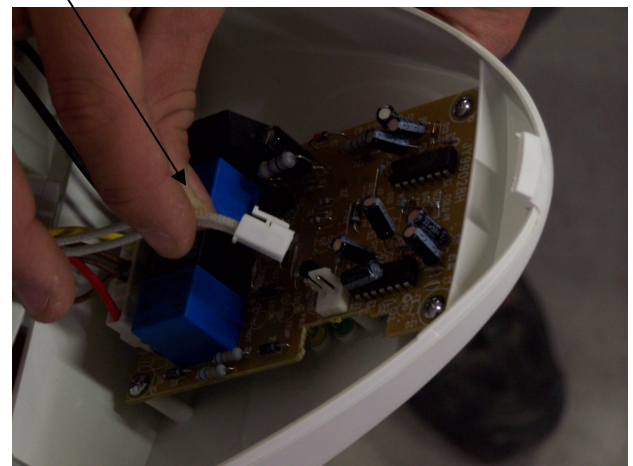
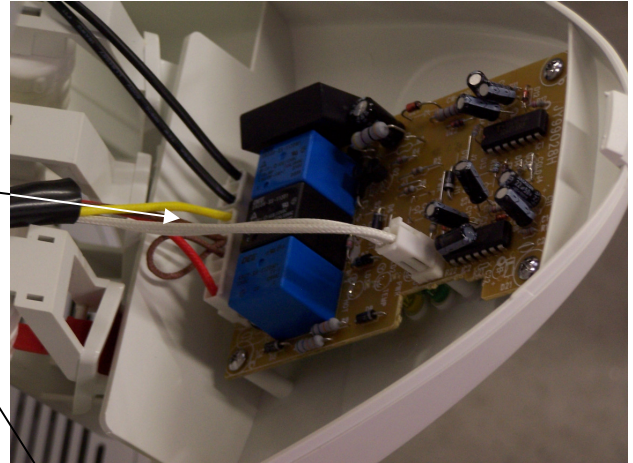

- 5.4 The cover should now be free from the cooler and can be placed on a work bench.
- 5.5 Remove 4 screws that hold the circuit board to the faucet cover. Lift off circuit board from the faucet cover.
- 5.6 Reverse above process to reinstall circuit board and faucet cover.

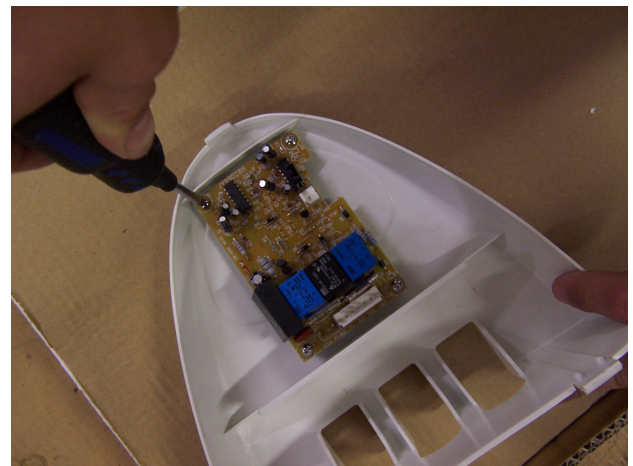

## 6. Remove/Replace Float Switch

6.1 Remove top lids from cooler

6.2 Remove main tank cover

6.3 Remove hot tank as described  
in this manual (sec. 7)

6.4 Remove back panel

6.4 Remove (9) screws holding main  
tank to frame

6.5 Disconnect silicon tubing from  
main tank (5 places). Access  
silicon tubing from back of  
cooler.

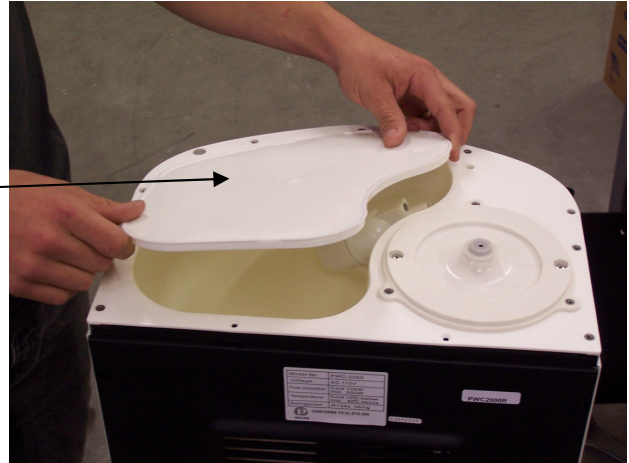

## 6. Remove/Replace Float Switch

Cont.

6.6 Tilt up edge of main tank to gain access to micro-switch assembly



6.6 Disconnect electrical terminals from micro-switch



6.7 Lift main tank out of cooler



6.8 Place main tank on work bench to remove float assembly

## 6. Remove/Replace Float Switch

Cont.

6.9 Remove micro switch by loosening and removing plastic nut.



6.10 Remove washer and activator rod

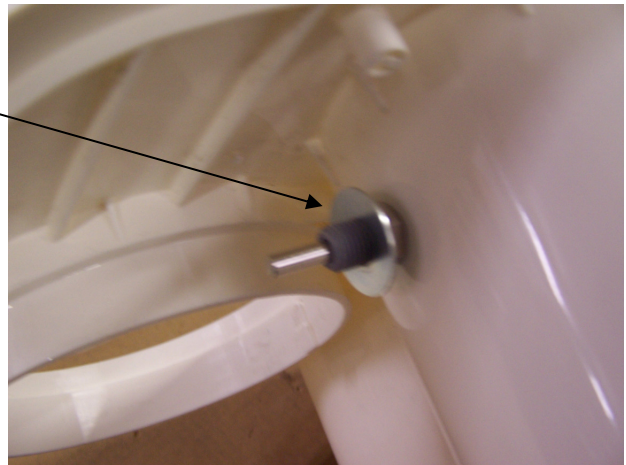

6.11 Remove metal nut and silicon washer



## 6. Remove/Replace Float Switch

Cont.

6.12 Remove float mechanism from main housing



6.13 Complete Float assembly (removed)

6.14 Replace new float assembly in reverse order

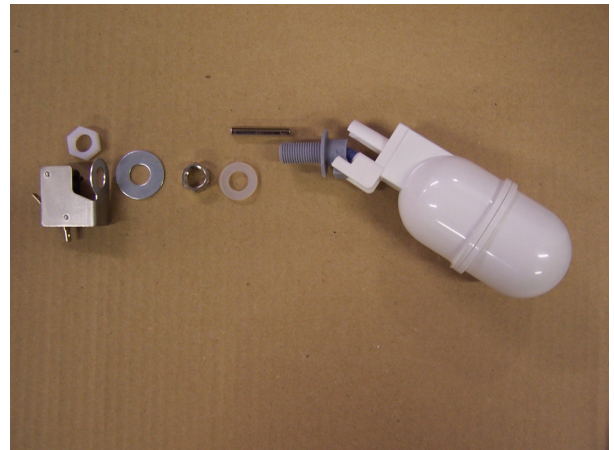

## 7. Remove/Replace Hot Tank

(for coolers built after 10/02)

7.1 With cooler top cover off, and back removed, remove screws (5 places) holding hot tank to main reservoir assembly.



7.2 Remove silicon tubing from hot tank (4 places)

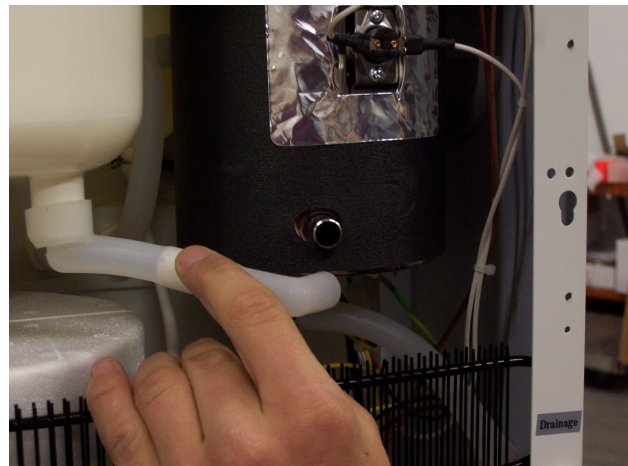



## 7. Remove/Replace Hot Tank

(for coolers built after 10/02)  
cont.

7.3 Remove electrical contactors from thermal sensors (4 places). See Figure 2 for wiring schematic

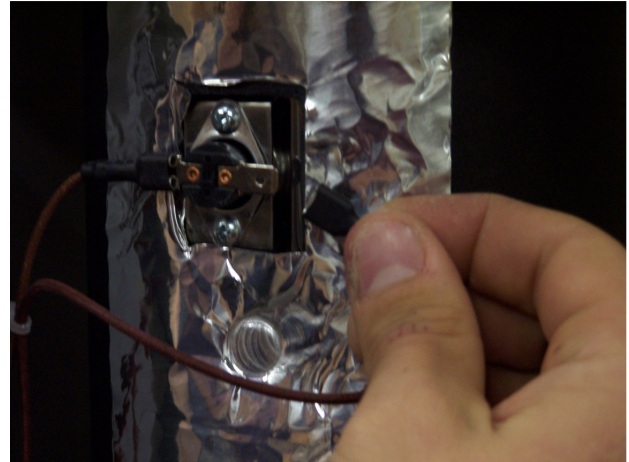

7.4 Lower hot tank and remove

7.5 Disconnect 2 electrical connectors at bottom of tank

7.6 To install hot tank, reverse the above steps



## 8. Remove/Replace Faucet

- 8.0 Remove back cover (as shown in section 4 )
- 8.1 Remove faucet cover (as shown in section 5)
- 8.2 Remove silicon tubing from back of faucet by pulling and working it off



- 8.3 Remove plastic nut from rear of faucet using 7/8" socket.



- 8.4 Once the nut is removed, faucet can be withdrawn from the front.
- 8.5 Reverse the above process to replace faucet.



## 9. Draining Cooler Tanks

Completely draining the tanks is required when shipping the cooler or when one of the tanks needs replacing. This procedure will allow you to remove all the water from the cooler.

9.0 Hot Tank Drain: Using a flat head screw driver, pry the hot tank plug out until you can grasp it with your fingers.



9.1 Remove the plug with fingers. Water will pour from the port.



9.2 Cold Tank (and Main Tank) Drain: On the left rear of the cooler, unscrew the metal cap. Water will pour from this port. Don't forget to replace the cap and the plug after the tanks are empty.



9.3 Drain any remaining water in the system by depressing the faucets.

## 10. Remove/Replace Hot Tank Sensor

There are two thermal sensors on the hot tank. The lower sensor controls the heating element function and the upper sensor is for high temperature cut out. If the hot tank is not working one or both of the sensors may have failed in the open position. To check for this condition, unplug the cooler from main power, disconnect one of the electrical terminals on the sensor. Using an ohm meter, check for continuity. If there is no continuity, the sensor is bad and must be replaced.

- 10.0 Remove the top and back of the cooler per section 4 to gain access to the hot tank.
- 10.1 The hot tank does not have to be removed from the cooler to change the sensors
- 10.2 Remove the electrical terminals from the sensor
- 10.3 Remove the two screws that hold the sensor to the tank. The sensor can now be removed
- 10.4 Reverse the above procedure to replace the sensor

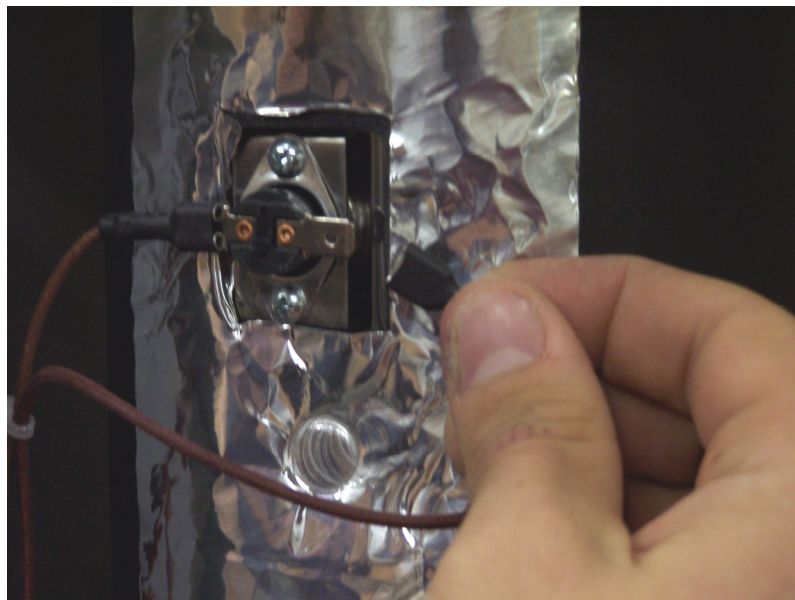

## 11. Remove/Replace Cold Temperature Switch and Sensor

The cold temperature switch includes the thermal sensor which is attached to the switch. The sensor probe (integral with the switch) is inserted into the Receptacle at the bottom of the cold tank.

11.0 Remove adjustment knob using a flat head screwdriver



11.1 Loosen (2) screws holding the switch to the mounting plate.

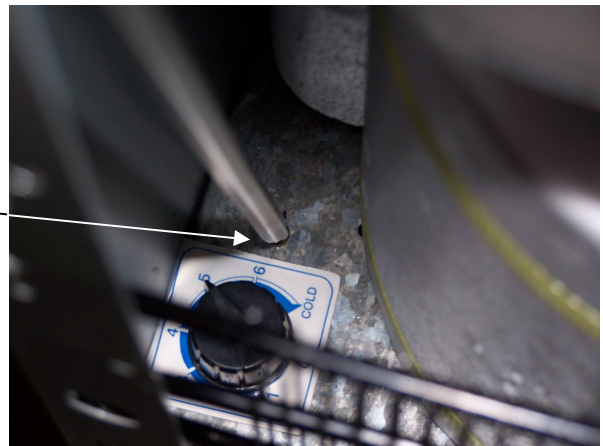

## 11. Remove/Replace Cold Temperature Switch and Sensor

Cont.

11.2 Carefully remove the sensor probe from the receptacle at the bottom of the hot tank.

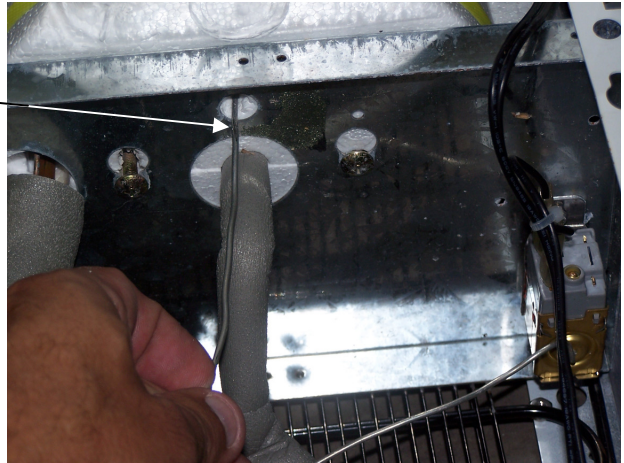

11.3 Disconnect (2) electrical terminal wires.

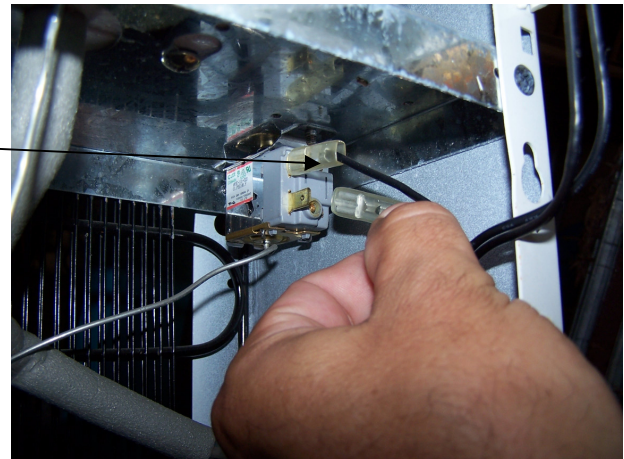

11.4 Lift and remove switch assembly from mounting plate.

11.5 Replace new switch in reverse order.

## 12. Sanitization Procedure

The sanitization procedure is performed to reduce/eliminate any bacteriological growth in the cooler tanks and dispensing plumbing. Bacteriological growth can be the cause of some taste in the water.

The procedure is as follows:

1. Mix ½ teaspoon of common household bleach (5.25%) with 5 gallons of clean water.
2. Unplug the cooler from the power source.
3. Drain all water from the cooler tanks.
4. Pour the sanitizing solution into the main (room temperature) tank until full.
5. Open all 3 spigots to allow sanitizing solution to fill the dispensing faucets. Close the faucets.
6. Let the sanitizing solution stand in the cooler for 10 minutes.  
**CAUTION:** Leaving the sanitizing solution in the cooler for more than 10 minutes can cause taste problems in the water.
7. Completely drain the sanitizing solution from all the tanks.
8. Fill the main (room temp.) tank with clear tap water to rinse out the sanitizing solution.
9. Completely empty the rinse water from the tanks.
10. The cooler is now sanitized and ready for use.

## 13. Trouble Shooting

### Water not cold from cold tank

(Water dispenses from spigot but is not cold)

<u>Possible causes</u>	<u>Solution</u>
1. Cooler not plugged in	Make sure power cord is plugged into wall socket
2. Power switch not on	Make sure cold power button on front panel is on
3. Adjust temperature control	The thermostat temperature control adjustment is located on the right rear of the cooler
4. All cold water has been drained	Cooler needs time to recover. wait 10 minutes until water cools
5. Water not dispensing from cold spigot	Cold tank is frozen. Turn down cold temperature adjustment



## 13. Trouble Shooting

Cont.

### No Hot Water from Hot Tank

Possible Causes	Solution
1. Cooler not plugged in	Make sure power cord is plugged into wall socket
2. Power switch not on	Make sure Hot power button on front panel is on and illuminated
3. Electrical terminal disconnected	Check to see that both wires are connected to the heating element terminals. These are located at the bottom of the tanks
4. Heating element failure due to scaling	Check for continuity across hot tank heater terminals. To do this, unplug unit from wall power. Disconnect one of the connector at the heating element terminals (at bottom of tank). Using an ohm meter, check for continuity across the 2 terminals. If there is no continuity (open), the tank must be replaced.

## 13. Trouble Shooting Cont.

### No Hot Water from Hot Tank cont.

#### Possible causes

#### Solution

##### 5. Thermal sensor failure

The thermal sensors are attached to the hot tank. The upper sensor is a 105 °C sensor and functions as an over heat safety. The lower sensor is a 85 °C sensor and controls the heating element function. The lower sensor would be the problem if there was no hot water. To see if the sensor is functioning properly, first unplug the cooler from the wall. remove the terminal from the sensor. Using an ohm meter, check for continuity. If there is no continuity (open), replace sensor.

## 13. Trouble Shooting Cont.

### No Hot Water from Hot Tank cont.

An indicator of a hot tank problem can also be the lights on the front control panel. Below is a table of trouble shooting help.

If the Hot Tank is not heating and the front panel lights are:

<u>Front Panel Lights</u>	<u>Cause</u>	<u>Check</u>
Hot Power – on Heating - on	Heating element disconnected or burned out	No Continuity across heating element
No lights at all Including cold power	Upper thermal sensor disconnected or burned out	No Continuity across upper thermal sensor
Hot Power – on Keep Warm – on Heating - off	Lower thermal sensor disconnected or burned out	No Continuity across lower thermal sensor

# 13. Trouble Shooting

Cont.

## Float Adjustment (Model PWC-2000)

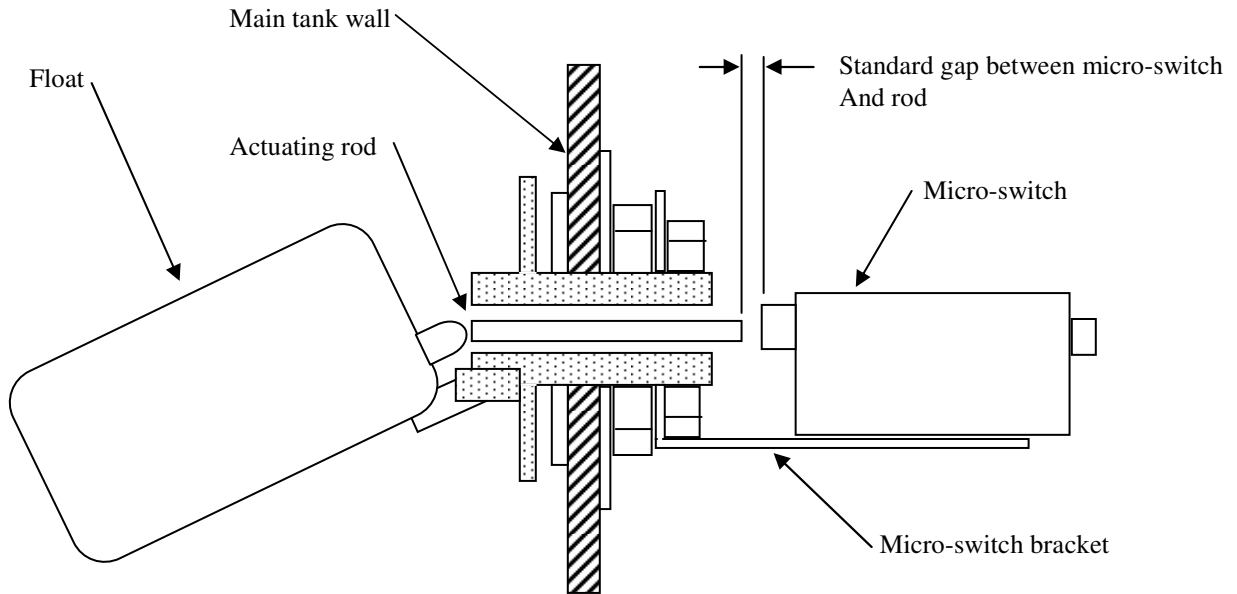

Float rotated 90° for clarity

To lower the water level in the tank, bend the micro-switch bracket towards the activator rod, reducing the gap between the micro-switch and the rod

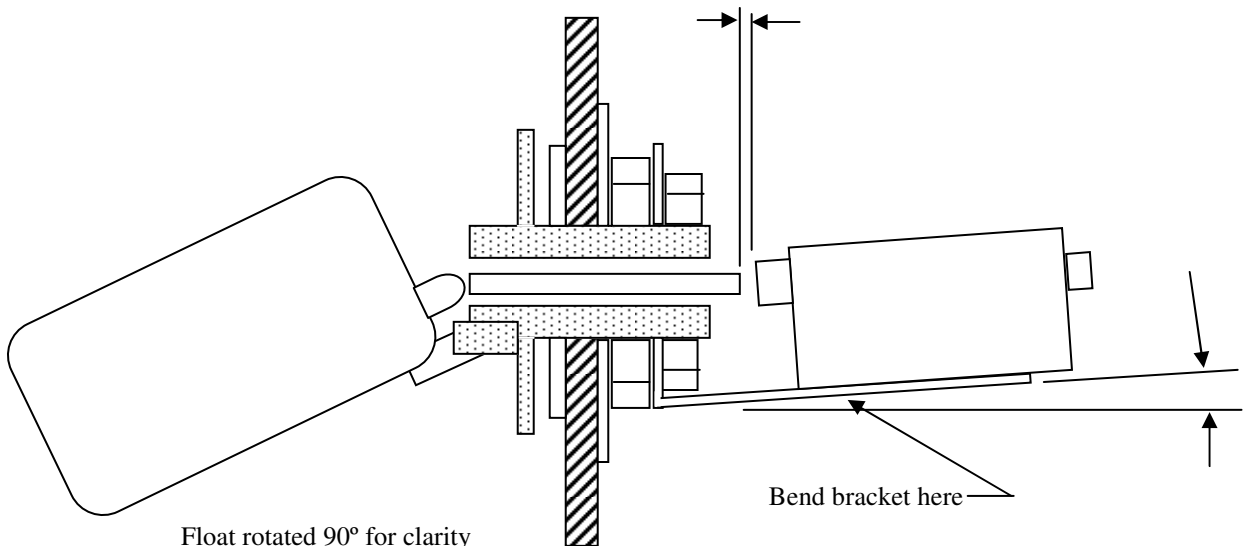

Float rotated 90° for clarity

## 14. Specifications

Voltage/Frequency	120 VAC/ 60 Hz
Weight (dry)	48 lbs.
	Model PWC-600/2000
Total Water Capacity	3.2 gallons
Room temp. tank	2.2 gallons
Hot tank	0.5 gallons
Cold tank	0.5 gallons
Power Consumption Total	600 Watts
Hot Tank	500 Watts
Cold Tank	100 Watts
Temperature	
Hot	180 °F average
Cold (adjustable)	38 °F average
Refrigerant	R134a 36 mg.